



*Serving nature and you<sup>®</sup>*

# **BLACK BEARS of Missouri**

*A Guide to Nuisance Prevention*

Missouri Department of Conservation

DAVID Besenger

Copyright © 1994, Revised 2019 by the Conservation Commission of the State of Missouri

Equal opportunity to participate in and benefit from programs of the Missouri Department of Conservation is available to all individuals without regard to their race, color, religion, national origin, sex, ancestry, age, sexual orientation, veteran status, or disability. Questions should be directed to the Department of Conservation, PO Box 180, Jefferson City, MO 65102, 573-751-4115 (voice) or 800-735-2966 (TTY), or to Chief, Public Civil Rights, Office of Civil Rights, U.S. Department of the Interior, 1849 C Street, NW, Washington, D.C. 20240.

# CONTENTS

<b>Introduction to Missouri’s black bears</b> .....	4
<b>History</b> .....	4
<b>Characteristics</b> .....	5
Breeding .....	5
Habitat and food .....	5
Denning .....	5
<b>Prevention—The key to nuisance control</b> .....	6
How to avoid damage by black bears .....	6
How to identify the presence of black bears .....	6
<b>Potential problems and solutions</b> .....	7
Bee hives .....	7
Livestock and other domestic animals .....	7
Orchards .....	8
Corn and sorghum crops .....	8
Trash receptacles .....	9
Campgrounds .....	9
<b>Appendix—Electric fencing tips to discourage bears</b> .....	10

The Missouri Department of Conservation would like to thank the University of Massachusetts Cooperative Extension System and the Massachusetts Division of Fisheries and Wildlife for various materials and ideas used to create this manual.

**Writer:** Gene Kelly  
**Illustrators:** David Besenger and Charles W. Schwartz  
**Editor:** Joan McKee

## INTRODUCTION TO MISSOURI'S BLACK BEARS

Most people enjoy catching a rare glimpse of Missouri's largest mammal, but in a few instances, young bears can cause problems as they set off on their own.

When bear problems arise, the Missouri Department of Conservation is here to help preserve personal property while ensuring that a viable black bear population continues to develop in the state. With investments in long-term black bear deterrents and a willingness to tolerate and learn about bears, people and bears can co-exist.

The information in this booklet will help you to better understand Missouri's black bears and avoid nuisance bear problems.



Charles W. Schwartz Illustration

## HISTORY

Black bears are the most common and widely distributed of the three bears in North America. Their original range extended throughout the continent's forested areas and into Mexico. Black bears are now found primarily in less settled, forested regions in the United States and Canada.

According to many pioneers and settlers, black bears were abundant in Missouri during the 18th and 19th centuries. Many early county histories contain notes and reports of the remarkable number of bears in all areas of the state.

Bears were a staple item for settlers and were widely used for food,

as well as for their fat and skins. Black bears were more commonly killed by pioneers and early travelers than any other mammal, other than deer.

By the 1840s, black bears were rare in north Missouri and, by 1894, were reported to be almost extinct in the Ozarks. Bear sightings became increasingly rare in Missouri by the 1950s; however, it was generally believed that they remained in portions of the Ozarks.

Black bears were occasionally sighted, but it was not known whether they were residual wild bears or captive bears brought in from other states that later were released or escaped.

Between 1959 and 1967, the Arkansas Game and Fish Commission captured 254 black bears in Minnesota and Manitoba and released them in the Ozark and Ouachita mountains of western Arkansas. Since the initiation of Arkansas' program, black bear sightings have become more numerous in Missouri.

Black bear numbers are increasing in the Ozarks. Biologists have found evidence that bears are reproducing in Missouri, and they expect our bear population to continue to grow. As more bears begin inhabiting the Show-Me State, bear nuisance complaints will increase.

## CHARACTERISTICS

The black bear is the smallest bear in North America and the only one native to Missouri. Adult males generally weigh 200 to 600 pounds, and adult females weigh 100 to 300 pounds. Although most bears in Missouri are black, color can vary from brown to blond.

The black bear has an acute sense of hearing and smell, but relatively poor eyesight. Although it is not considered one of the more dangerous animals, it can be unpredictable. Nearly all physical injuries to people by black bears occur in a campground setting and involve a "panhandler" bear. The black bear possesses great strength and agility, and is an excellent climber, runner and swimmer.

### Breeding

Both male and female black bears usually become sexually mature at 3 1/2 years of age. Except for females with cubs and during the breeding season, black bears are solitary animals. The breeding season for black bears occurs during June and July. Female bears will chase off their yearling cubs in May or June just before mating.

Yearling females usually establish a home range near the area where they were raised, while yearling males may wander long distances and for many months in an effort to establish a new territory. This dispersal behavior of young males accounts for many of the bear sightings and nuisance complaints during the spring and early summer months.

Cubs are born while the females are in winter dens, usually late January or early February. Normally, two cubs are born, but three or four are not uncommon. Cubs are born blind and helpless and weigh about 8 ounces. The cubs stay with the female throughout the next year and normally den with her as yearlings.

### Habitat and food

Black bears prefer large forested tracts of mast-bearing trees or shrubs with areas of thick underbrush. Dense cover or inaccessible areas are important to bears for denning and to escape harassment from people and dogs. Areas of old growth forests that provide den trees are a valuable, but not essential, habitat.

Black bears are omnivorous, but nearly 90 percent of their diet is vegetable matter. During spring and early summer, bears prefer forest openings, which provide forbs and fruits such as blueberries, blackberries, raspberries, cherries, pokeberries and nettles.

In addition to ants and termites, bears also will eat carrion and newborn white-tailed deer when they find them.

As summer approaches, bears take advantage of ripening fruit and berries, and often spend considerable time in recent clearcut areas and habitats with lots of shrubs. By mid-summer, bears usually have regained the weight they lost during the winter.

Mast, especially acorns, has been termed the single most important factor limiting reproduction, growth and survival of black bears. Bears seek out foods that are high in fat and protein to replenish fat stores prior to winter denning.

Mature stands of mixed oak-hickory trees are often used by bears during fall. These older stands also provide bears with den trees.

### Denning

During late fall and winter, bears enter dens and undergo a winter dormancy but do not actually hibernate like woodchucks or bats. Bears probably den to circumvent winter food shortages.

During denning, bears rarely eat, defecate or urinate. Their body temperature and heart rate are reduced, and their metabolism functions at about 40 percent of normal. Bears can be aroused easily from their winter dormancy.

Denning sites are important components of bear habitat. They protect bears from adverse weather and harassment from humans, as well as from other bears. Females with cubs are protected from predators such as free-running dogs and coyotes. Typical den sites include rock caves and crevices, tree blow-downs, ground nests and tree cavities.

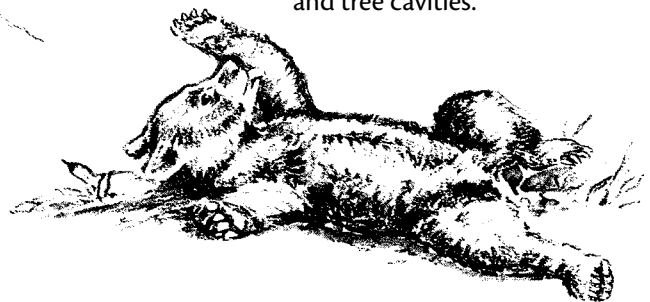
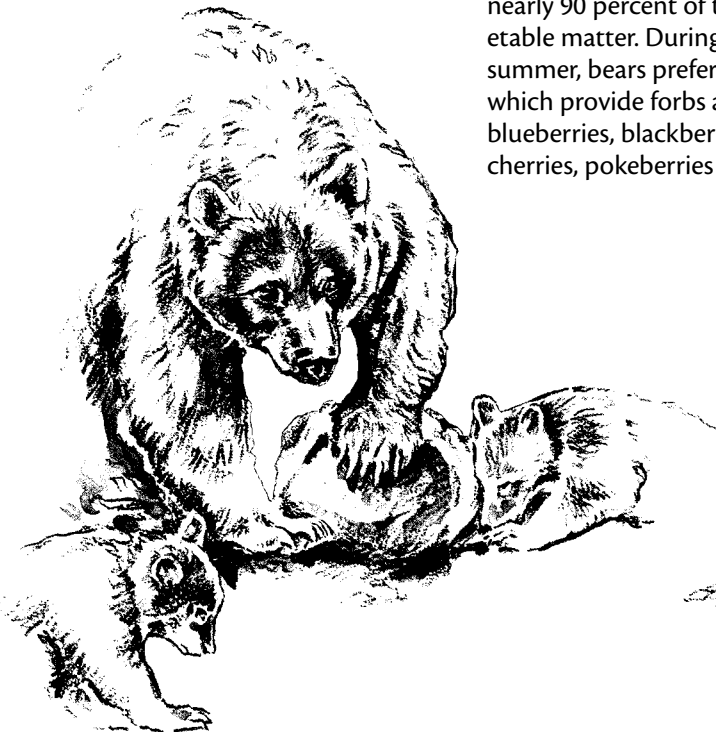

Charles W. Schwartz Illustration

## PREVENTION—THE KEY TO NUISANCE CONTROL

Nuisance black bears are not a statewide problem in Missouri. Generally they are confined to the southern counties during the spring and summer months. In the early spring, black bears emerge from their dens very hungry at a time when natural foods are scarce. It also is in the spring that family groups break up and breeding season begins.

Most of the black bears that cause nuisance problems are yearling males that have been driven away by their mother, and threatened or attacked by older males. In their search for food, it is most often these young males that come into contact with humans and cause problems.

Black bears can adapt to changes in habitat or food sources, and will often tolerate contact with people in their search for food. In suburban areas, for example, bears may overcome their fear of people when they discover bird feeders or a readily available supply of pet food.

Also, bears are capable of remembering from year to year the location of reliable food sources. Therefore, it is important to take precautions to prevent raids from occurring and to avoid enticing bears with food.

Although bears are secretive and shy by nature, they are wild and unpredictable animals. They may become aggressive if abused or unduly provoked.

Precautions should be taken to avoid confrontations and loss before bear damage occurs. The most effective and long-lasting success will be achieved through damage prevention rather than responding to a bear that already has discovered a food source. Bears learn rapidly and if their activities are rewarded by food, then barriers or harassment techniques will be less effective.

As is true with most problem wildlife, no technique will provide absolute security from nuisance problems. However, certain measures initiated in a timely manner can greatly reduce the extent and severity of bear damage.

### How to avoid damage by black bears

Never intentionally feed bears! Feeding makes them lose their fear of being around people and usually results in the bears having to be destroyed. To reduce the potential of damage, don't encourage their presence or attract them to your property.

The following pages offer a more detailed review of bear damage, its identification, what to do if damage occurs, and where to go for help.

### How to identify the presence of black bears

The first step in solving a damage problem is to be sure bears, and not some other animals, are the cause. If you don't actually see the animal doing the damage, check the site carefully for clues, such as tracks, claw marks, feces and hair. Bears, the largest and heaviest wild mammal now living in Missouri, will leave behind bigger signs of their presence.

Black bears have five toes on each foot. Their hind footprint, usually about 7 inches long, resembles a person's footprint. The front footprints are smaller, often measuring between 3 1/2 to 4 inches wide. Claw marks are not always visible in the footprints.



*Black bears look pigeon-toed and bow-legged when they walk. Their front footprint consists of only the sole and toe impressions. Claw marks are not usually visible. The hind foot leaves a distinctive heel impression, much like a human footprint.*

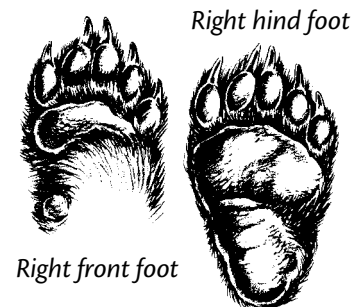

Charles W. Schwartz art is courtesy of the State Historical Society of Missouri, Columbia.

## POTENTIAL PROBLEMS AND SOLUTIONS

### Bee hives

#### Preventing black bear damage

- Keep mowed, cleared corridors around hive sites.
- Avoid placing hives in abandoned areas or near wooded, overgrown locations.
- Locate hives as close together as possible because they are easier to protect.
- Don't attract bears to your property by feeding them or providing supplemental food.
- Erect temporary or permanent electric fencing. See appendix on page 10.

#### Identifying black bear damage

- Hives are knocked over, scattered and torn apart.
- Honeycombs or larvae have been destroyed or consumed.

**NOTE:** Skunks and raccoons also may destroy bee hives. Their tracks and feces are much smaller, however, and the extent of their damage is less destructive than that of a bear.

#### What to do if damage occurs

- Contact the county conservation agent.
- Use pyrotechnics or other harassment techniques to frighten bears away.



- Erect temporary or permanent electric fencing baited with bacon or an open can of sardines. See appendix on page 10.

### Livestock and other domestic animals

#### Preventing black bear damage

- Avoid pasturing livestock in abandoned locations, areas with heavy cover, or fields adjacent to probable corridors used by bears.
- Do not leave carcasses of dead livestock exposed. Bury or incinerate them completely.
- Avoid feeding bears or providing supplemental food on your property that might attract bears.
- When possible, pen livestock near or in the barn at night, particularly pregnant animals and those with young. Because afterbirth material attracts bears, coyotes and other predators, it is a good idea to provide a place in a barn for livestock to give birth. If this is not possible, clear pastures and fields of all afterbirth material.

#### Identifying black bear damage

- Livestock surviving a bear attack will often show tooth marks on the neck at the base of the skull or long, 1/2-inch-wide claw marks on the shoulders.

- Livestock that have succumbed to a bear attack often will have a broken neck or back as a result of blows from the bear's paws.
- Bears will often drag or carry a carcass away from the kill site, cache it, and return regularly to feed on it.
- Bears often will strip back or reverse the skin of larger prey, particularly along the back, and lick the meat from the bones. They do not normally eat the bones and skin.
- The udder of lactating female prey is highly preferred by bears and often will be eaten first.
- Inexperienced bears might expose the intestines, but muscle tissue usually is preferred and consumed.



**NOTE:** Care must be taken to distinguish bear damage from that of other carnivores, especially coyotes and domestic dogs. Coyotes usually kill their prey with bites to the neck, and feed on internal organs and hindquarters first rather than on the back or shoulders. Coyotes and dogs will not make long, 1/2-inch-wide claw marks on the body. Also, coyotes and dogs usually do not strip back the prey's skin, but they will eat and chew the bones.

#### What to do if damage occurs

- Contact the county conservation agent.
- Consider modifying or replacing existing fence with high-tensile, low impedance electric fence around animal enclosures baited with bacon or an open can of sardines. See appendix on page 10.
- Use guard dogs to discourage bears and warn of their presence.
- Move livestock to another pasture.
- Use pyrotechnics or other harassment techniques to frighten bears away.

## POTENTIAL PROBLEMS AND SOLUTIONS CONTINUED...

### Orchards

#### Preventing black bear damage

- Keep mowed, open corridors around the orchard and between the trees.
- Don't attract bears to your property by feeding them or providing supplemental food.
- Put up an electric fence. See appendix on page 10.
- Use guard dogs to discourage bears from coming into the orchard.

#### Identifying black bear damage

- Small trees are stripped of branches or mature trees have large limbs broken in the tops.
- Claw marks may be seen 4 1/2 to 6 feet above the ground.

#### What to do if damage occurs

- Contact the county conservation agent.
- Use single-strand polypropylene electric tape around the perimeter of the orchard or around individual trees. Bait the fence with bacon or an open can of sardines. Prefabricated electric net fence can be used around individual trees. Consider installing permanent, high-tensile, electric fence around the orchard. See appendix on page 10.
- Use pyrotechnics or other harassment techniques to frighten bears away.

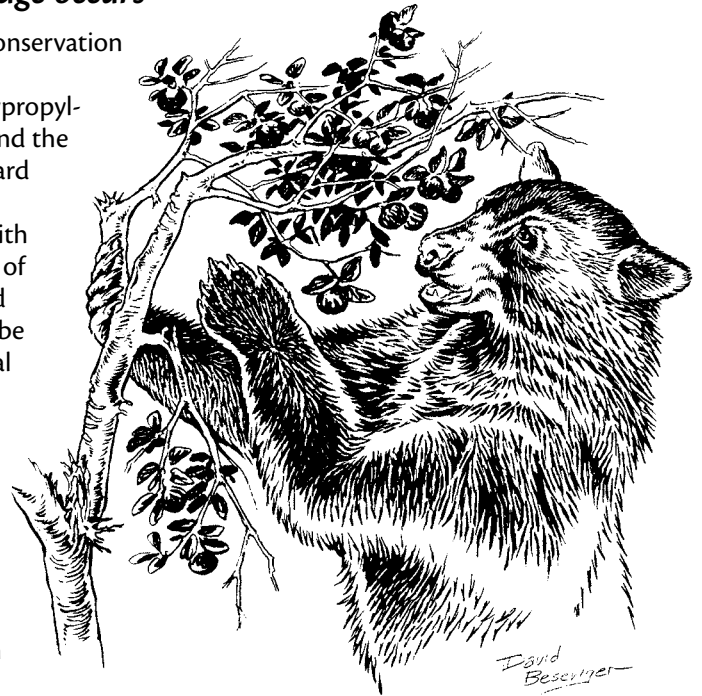

### Corn and sorghum crops

#### Preventing black bear damage

- Keep mowed, open corridors around and between fields.
- Don't attract bears to your property by feeding them or providing supplemental food.

#### Identifying black bear damage

- Look for large, circular patches within the field's interior where stalks have been pulled inward and flattened or broken.
- Ears of corn will be completely eaten or cleaned of kernels. More plants may be damaged than are actually consumed.
- The damage occurs at the milk-stage of development.

**NOTE:** Take extra care to examine signs of damage because a variety of animals eat corn. Raccoons often pull down stalks, strip the husks and chew kernels from an ear, but normally do not cause the large circular patches of damage. Other animals, such as deer and coyotes, will nip at the ears and silk. Beavers will chew, fell and remove the stalks.

#### What to do if damage occurs

- Contact the county conservation agent.
- Keep guard dogs to discourage bears and warn of their presence.
- Put up single-strand poly-propylene electric tape around fields or at least on the most exposed side or sides of a field as the crop matures, especially just prior to and at the milk-stage of development. Bait the fence with bacon or an open can of sardines. See appendix on page 10.
- Use pyrotechnics or other harassment techniques to frighten bears away.

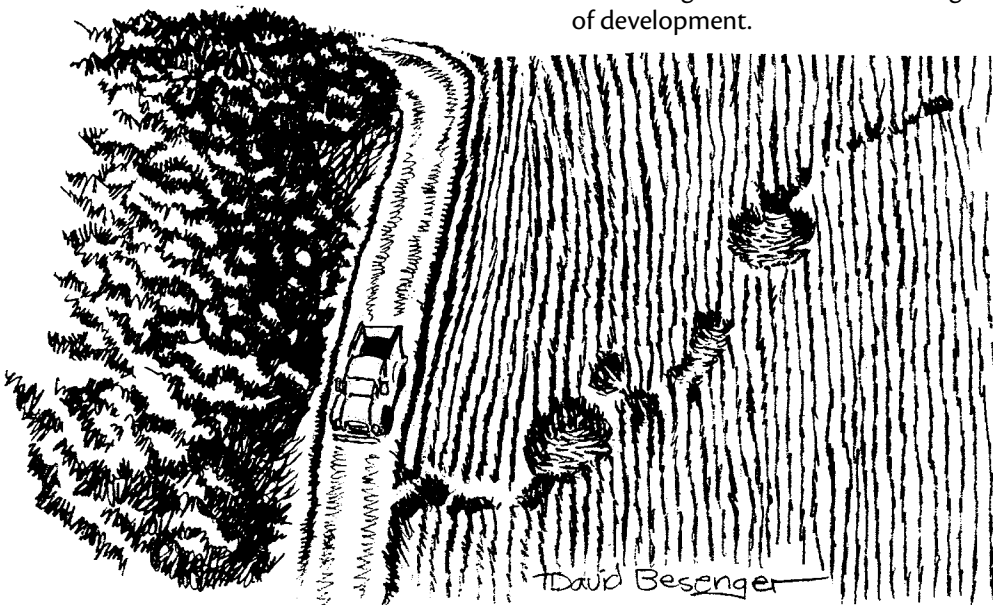



## Trash receptacles

### Preventing black bear damage

- Empty trash cans as often as possible, and wash with a disinfectant to reduce the food odors.
- Keep trash containers inside at night. Place trash and garbage outside only on the day of pickup.
- Outdoors, use large trash bins that have metal, lockable lids. Keep lids locked at night.
- Secure large, outdoor trash bins so they cannot be turned over.
- Empty large, outdoor trash bins at least once a week and wash with disinfectant.

### Identifying black bear damage

- Trash containers are knocked over and the contents scattered.
- Large, outdoor trash bins are turned over with garbage, plastic bags and wrappers sometimes carried 100 yards away and scattered.

**NOTE:** Care must be taken not to confuse bear damage with that of raccoons, dogs and other scavengers that commonly knock over trash cans and scatter the contents.

These smaller animals often remain inside a large trash bin to eat, whereas bears will usually remove the contents and scatter them over a considerable area around the receptacle.

### What to do if damage occurs

- Contact the county conservation agent.
- Erect temporary or permanent electric fencing baited with bacon, sardines or other food that attract black bears. See appendix on page 10.
- Use pyrotechnics or other harassment techniques to frighten bears away.

## Campgrounds

### Preventing black bear damage

- Keep your campsite clean and free of food odor, wash cookware and remove garbage daily. Do not leave garbage in the camp overnight.
- Pack food in closed containers and place them in your car or other secure place.
- When backpacking, place food in plastic or burlap bags and suspend over tree limbs at least 5 feet from the nearest tree trunk and at least 12 feet above the ground each night.

### Identifying black bear damage

- Food containers are broken into, and items are scattered about.
- Trash receptacles are raided.

### What to do if damage occurs

- Contact the county conservation agent.
- If the bear returns, make noise, bang pots and slowly retreat to a safe area.
- Consider moving to another camping area.



## APPENDIX

### Electric fencing tips to discourage bears

The specific design and list of materials for an electric fence will vary depending on each situation and the area to be protected. Suggested electric fencing options include: temporary, prefabricated electric net fencing with support posts incorporated into the fence; permanent, high-tensile, electrified wire on wooden posts; or temporary, poly-propylene electric tape on fiberglass posts. Use low-impedance fence chargers.

If the bear already has raided the area, bait the fence with some of the bear's favorite foods. One proven method is to wrap strips of bacon on the low-intensity electrically charged wires. Another is to attach a partially open can of sardines to the charged portion of the fence with a piece of wire.

When the bear takes a bite of the food, it will get shocked and associate the pain with the food source. A surprised animal usually will not return.

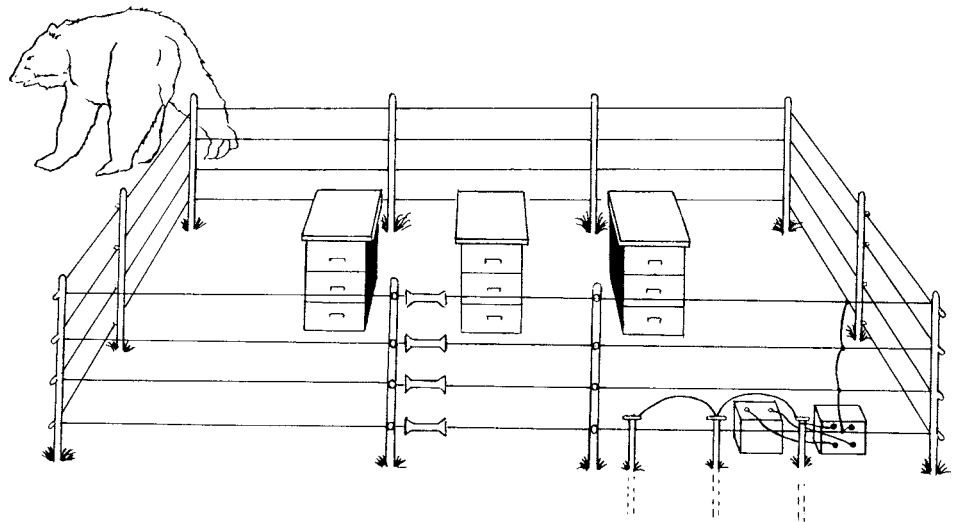

### Material list for an energized fence

Amount	Item
1	Energizer power source (batteries, solar, etc.)
As needed	Corner posts
As needed	Insulators for corner posts
As needed	Line posts
As needed	Line post clips or insulators
As needed	17 1/2-gauge steel wire or 16 1/2-gauge light barbed wire
4	Spring-type gate handles
2 or 3	4-foot galvanized steel ground rods
2 or 3	Ground rod clamps
As needed	Underground cable for lead out if using 110-volt power source
As needed	Electric fence warning signs
Optional	Chicken wire 2 feet wide, placed 6 inches from the fence all around the outside. Hold chicken wire in place with 12-inch plastic tent pegs. Connect negative or ground lead securely to mat using 18-gauge copper wire.

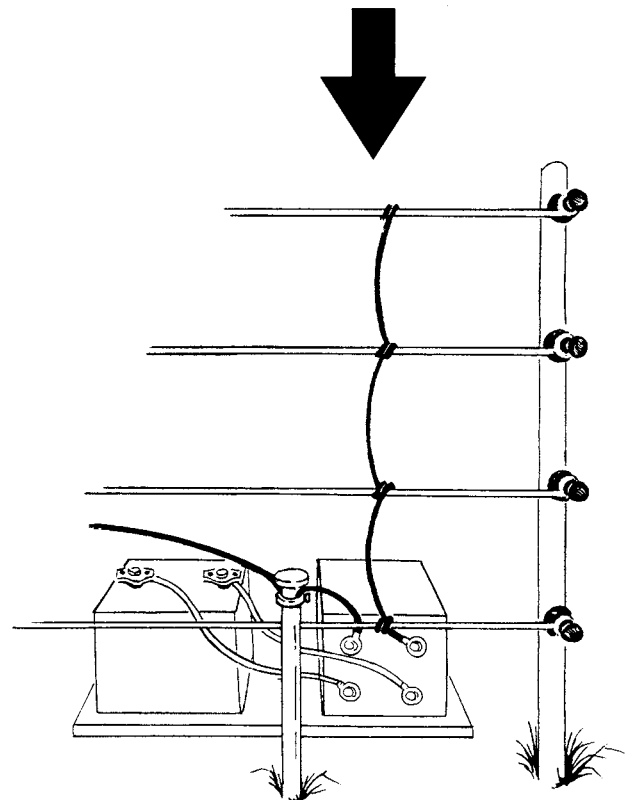



*Serving nature and you<sup>®</sup>*

[mdc.mo.gov](http://mdc.mo.gov)